

S 47 SX III

Truck-mounted concrete pump



Vertical reach		46.10 m
Concrete output	max.	162 m ³ /h
Pressure on concrete	max.	85 bar
Tare weight		approx. 31 t

MADE IN GERMANY
by SCHWING-Stetter 



RECORD BREAKING ENGINEERING

SCHWING GmbH
Heerstrasse 9-27
44653 Herne, Germany
Phone +98 021 - 224 286 75-8
Fax +98 021 - 224 286 78
@mr.pump_iran
www.saghargostar-co.ir

The S 47 SX III from SCHWING

Performance has never been easier

Large range, low weight, compact outrigger widths and straightforward operation: the new S 47 SX III by SCHWING offers everything you need to ensure maximum efficiency and safety during concrete placement. The intuitive operation of the 5-section roll-folding boom system combines with exceptionally large opening angles at stages 4 and 5 to optimise practical applications and therefore utilisation. Owing to the various EASyFlex support variants, the S 47 SX III requires far less space than before. And, thanks to its low unladen weight of slightly more than 31 tons and COC documentation supplied ex works, a legal permit for the S 47 SX III can be quickly obtained in all European countries. The S 47 SX III by SCHWING: rugged lightness for maximum range and excellent performance capability.



Pumpkit
Only the SX outriggers by SCHWING allows the longstroke pump kit P2525 with 2.50 m long pumping cylinders to be used in this class of machine. Advantages: even smoother operation and 15% less strokes than other pump kits available in this class.



Boom
Thanks to the easy to operate roll-folding system and large opening angles of the boom stages 4 (210°) and 5 (215°), the S 47 SX III is extremely flexible and safe during operation. Further benefits are the low unfolding height of just 9.80 m and large slewing range of 2 x 365°. To increase safety when pumping and to minimise the danger of blockages, only standard elbows with a large radius and camber of 275 mm are used with the boom pipes of the S 47 SX III.



Open hydraulic system
The open hydraulic system of the S 47 SX III converts the engine power efficiently into pump power with little loss. Thus, typical output rates can be achieved with a fuel-saving engine speed of just over 1000 rpm.



SX outriggers
The single section SX outriggers developed by SCHWING combine high torsional rigidity and excellent stability with minimum space requirement. The protected piston rod and internally laid hydraulic lines prevent damage and reduce service costs.



Concrete valve
Thanks to its intelligent design, the ROCK valve suffers significantly less wear and tear than other concrete valves. It is also quick to clean and is demonstrably easier to maintain. The advantages for the S 47 SX III: shorter servicing times, higher machine uptime and lower maintenance costs.



Supply control
The water box can be filled and emptied, and the water pump, agitator, spray hose, high pressure cleaner and compressor, all controlled via the standardised supply control. This is the standard for all SCHWING truck-mounted concrete pumps for greater clarity and ease of operation.



Remote control SC 30
The light weight, easy to use and comfortable SC 30 helps minimise fatigue, allowing the operator to focus on the job for extended periods. The powerful batteries guarantee an operating time of at least 8 hours.



VECTOR Control
The machine operator can inspect machine data, operating conditions and settings on S 47 SX III, changing various parameters, all through the intuitive VECTOR control. The integrated diagnostic system ensures safe operation and also reminds the operator when maintenance is necessary.



S 47 SX III Truck-mounted concrete pump

The assistance systems Active and Diractive

Active The boom damping system

More safety. More productivity.

Automatic concrete pumps by SCHWING have been known for their outstanding operating comfort and efficiency over many decades due to precise and quiet boom movements. Active, the optional boom damping system, eliminates boom vibrations almost entirely, which further increases operating comfort and safety. In contrast to other systems, the SCHWING Active system also remains fully functional with the boom at its maximum operating radius and the hydraulic cylinders fully extended, thus ensuring optimum boom damping in any position.

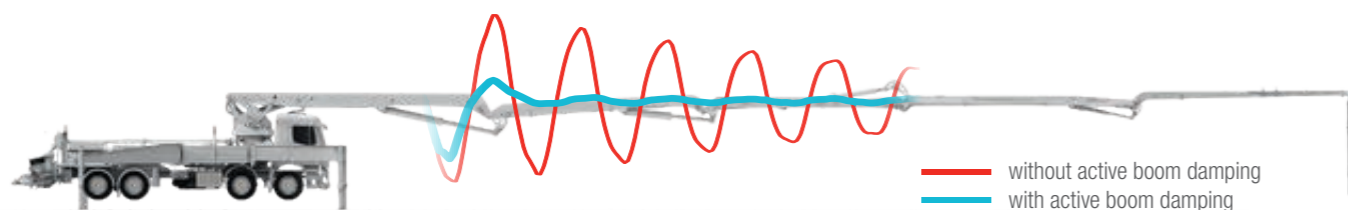

Diractive The versatile assistance system.

More comfort. More safety. More productivity.

Owing to the user-friendly functions of the optional Diractive system, the automatic concrete pump can be operated more comfortably, safely and efficiently. Thanks to the single-lever control, the movement of the end hose can be precisely controlled in the horizontal or vertical direction with only one joystick movement. The active boom damping system which is integrated into Diractive provides additional comfort and even more safety. The movement of individual boom stages can be fully disabled or a limited angular range can be specified to relieve the load on the machine operator in demanding site situations. The Diractive system also ensures that all boom stages can be controlled more precisely and sensitively and also accurately and evenly throughout the entire opening angle of the individual articulations. The assistance system can be operated intuitively and easily via the SC 50 radio control with large colour display.



Single-lever control



Boom damping system
Active



Locking and restricting



Precise actuation

Intuitive operation of the Diractive assistance system via the SC 50 radio control

SCHWING GmbH
Heerstrasse 9-27
44653 Herne, Germany
Phone +98 021 - 224 286 75-8
Fax +98 021 - 224 286 78
@mr.pump_iran
www.saghargostar-co.ir

EASy and EASyflex

The outrigger systems EASy and EASyflex extend the range of applications of the S 47 SX III. With EASy, the concrete pump can be safely supported on one side, if required. Thereby covering a working range of at least 130°. EASyflex provides further outrigger combinations and as such, more flexibility on the jobsite. In this way, pump applications can be achieved with the maximum working safety even in difficult, restricted spaces. More flexibility for more safety.

EASy

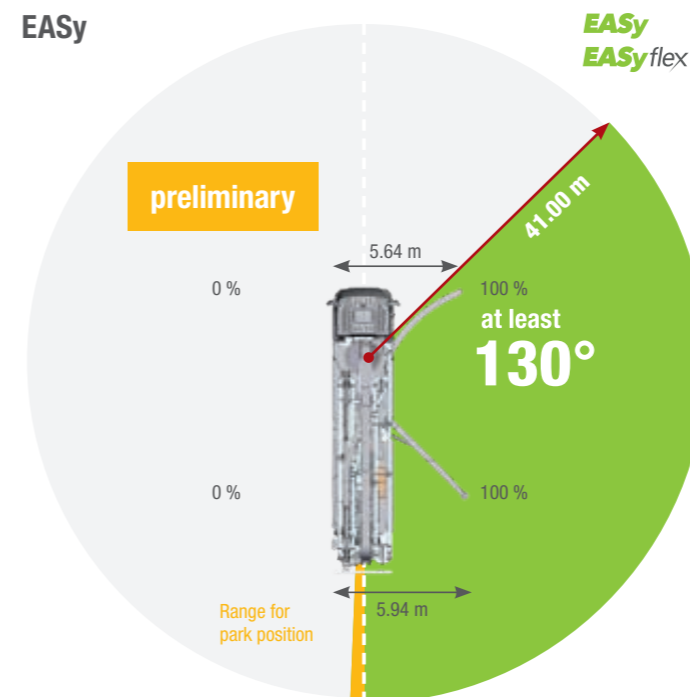

EASyExtend

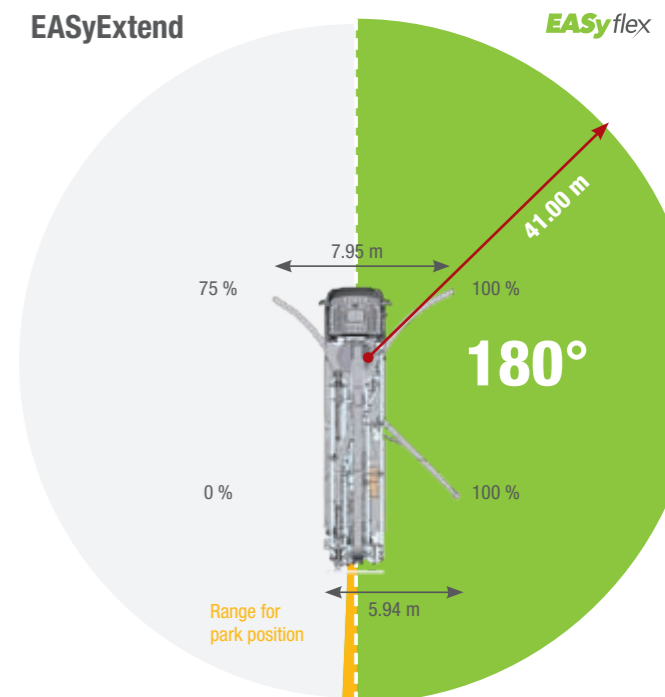

EASyFront

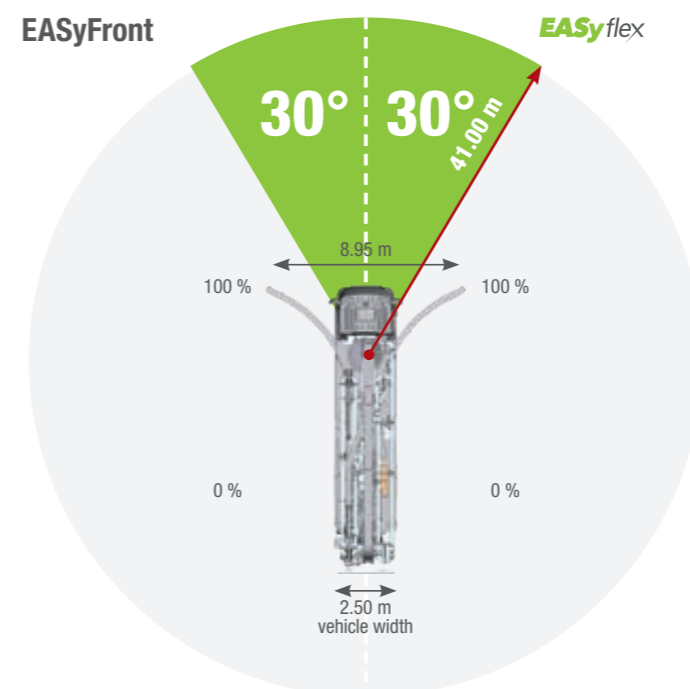

EASy with
EASyFront

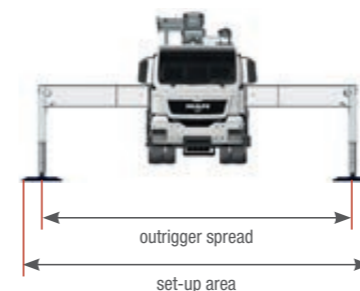
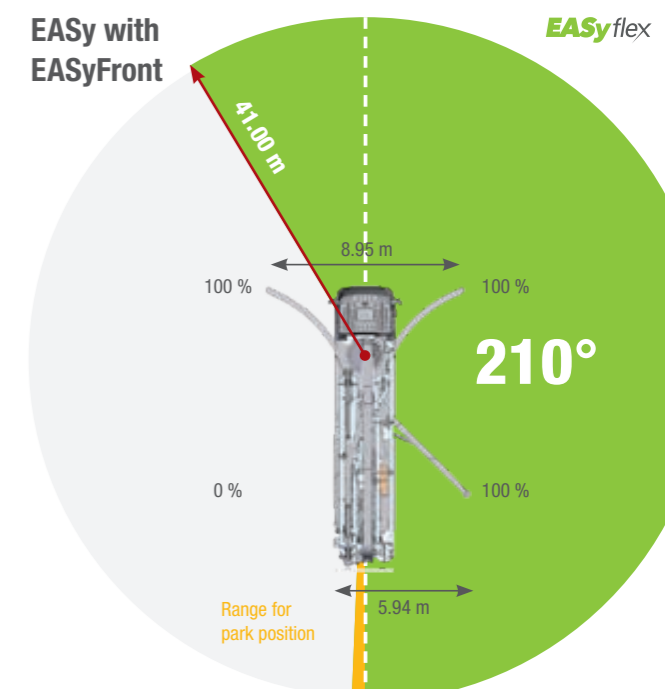

The outrigger spreads as specified are measured from the centre of the outrigger leg. Any cribbing or underlay timbers must be taken into account when determining the required set-up area.

S 47 SX III Truck-mounted concrete pump

Technical data

Performance				
Pump kit		P2023-110/75	P2025-120/80	P2525-120/85
Drive	l/min	636	535	636
Delivery cylinders	mm	230 x 2,000	250 x 2,000	250 x 2,500
Concrete output max.	m³/h	161	136	162
Pressure on concrete max.	bar	85	85	85
Stroke rate max.	1/min.	32	23	22
Concrete valve		B-ROCK	B-ROCK	B-ROCK
Hydraulic system				
Design		open system		
Hydraulic tank	l	480		
Boom				
Delivery line		DN 125		
Length of end hose	m	3.00 with end hose DN 125 / 3.50 (1.00 + 2.50) with end hose DN 112		
Vertical reach	m	46.10		
Reach depth	m	32.40		
Horizontal reach	m	41.00 (from centre of turret)		
Net horizontal reach	m	37.60 (from front of outriggers)		
Number of boom sections		5		
Height of the inflexion points	m	4.30 / 14.00 / 22.00 / 29.50 / 38.00		
Slewing range		2 x 365°		
Folding height	m	9.80		
Support				
Outrigger width, front	m	8.95		
Outrigger width, rear	m	9.60		
Outrigger load, front	kN	245		
Outrigger load, rear	kN	240		
Chassis (examples*)				
		Mercedes-Benz Arocs 3546	MAN TGS 35.420	
Axles configuration		8x4		
Wheelbase	mm	5,750		
Length	mm	11,880 / 11,850		
		11,850 / 11,810 (with / without underride guard)		
Miscellaneous				
Water tank	l	610		

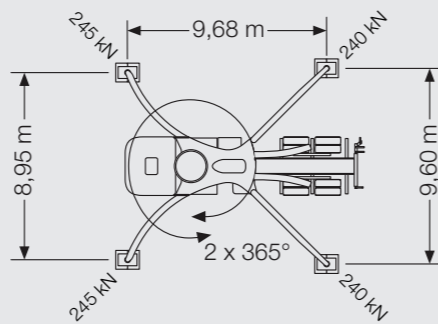

Working range

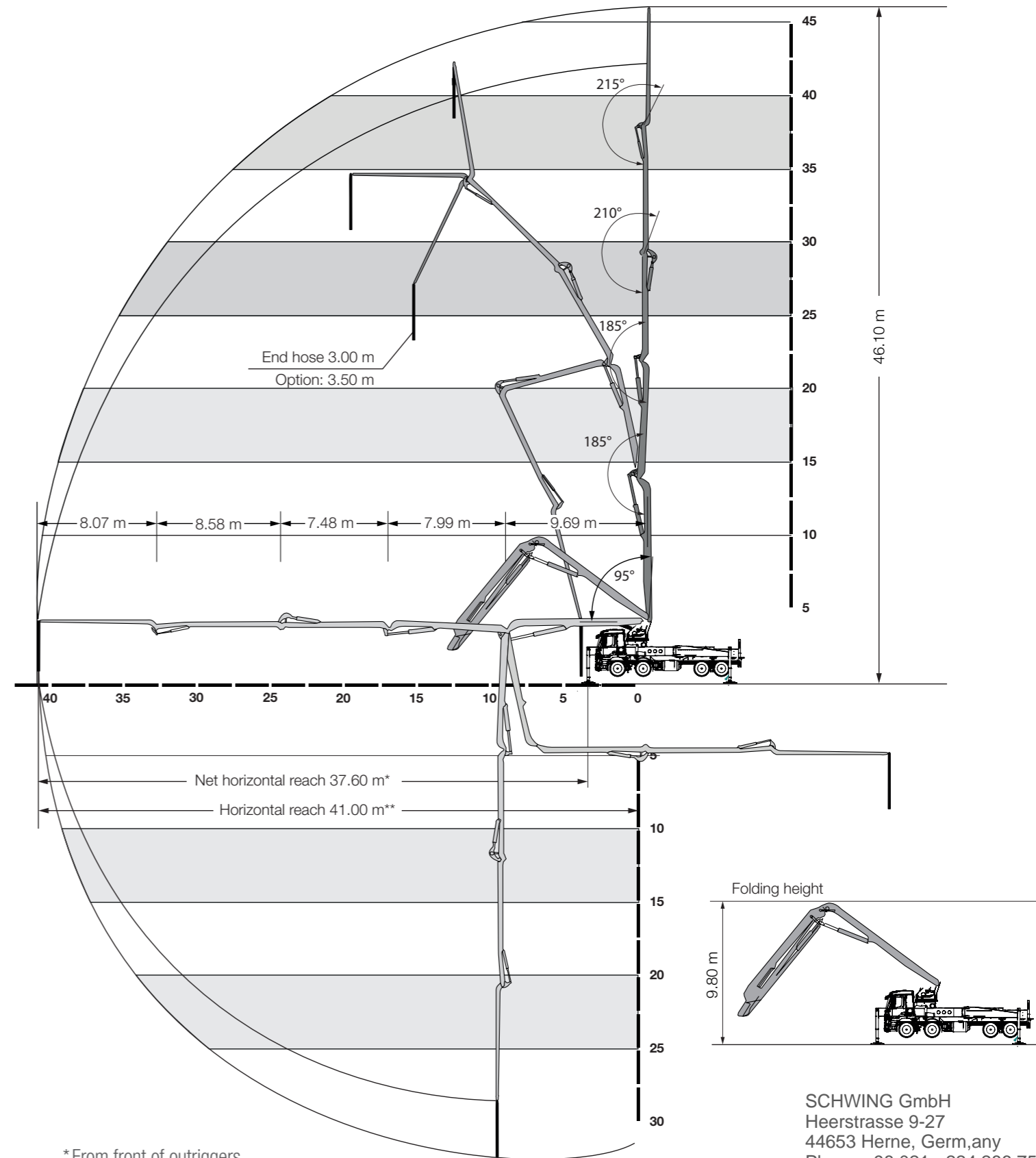

*From front of outriggers
**From centre of turret

SCHWING GmbH
Heerstrasse 9-27
44653 Herne, Germany
Phone +98 021 - 224 286 75-8
Fax +98 021 - 224 286 78
@mr.pump_iran
www.saghargostar-co.ir

*Can be mounted on different chassis frames



SCHWING concrete pumps
Efficiency as standard.



SCHWING
Stetter

SCHWING GmbH
Heerstrasse 9-27 · 44653 Herne, Germany
Phone +49 23 25 - 987-0 · Fax +49 23 25 - 72922
www.schwing-stetter.com · info@schwing.de

SCHWING GmbH
Heerstrasse 9-27
44653 Herne, Germany
Phone +98 021 - 224 286 75-8
Fax +98 021 - 224 286 78
@mr.pump_iran
www.saghargostar-co.ir

Stetter GmbH
Dr.-Karl-Lenz-Strasse 70 · 87700 Memmingen, Germany
Phone +49 83 31 - 78-0 · Fax +49 83 31 - 78 275
www.schwing-stetter.com · info@stetter.de

Subject to technical and dimensional modifications. Illustrations are non-binding. The exact standard specification, the scope of delivery and the technical data are detailed in the offer.